

MATEMATİK

Ali İhsan TARI
İnş. Yük. Müh.

F5 tuşu slaytları çalıştırmaktadır.

www.danef.net





WERDIHU

çember ... circle

www.danef.net





HURAYE

daire

www.danef.net



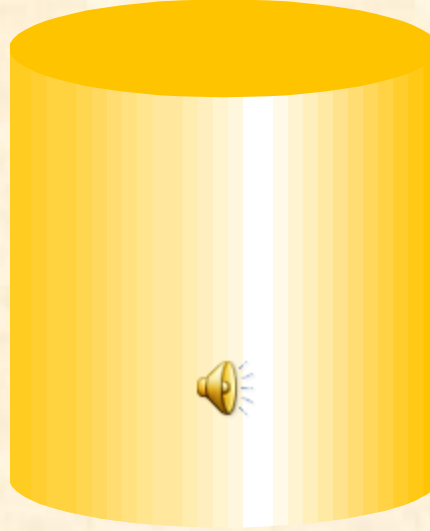

LOW

silindir ... cylinder

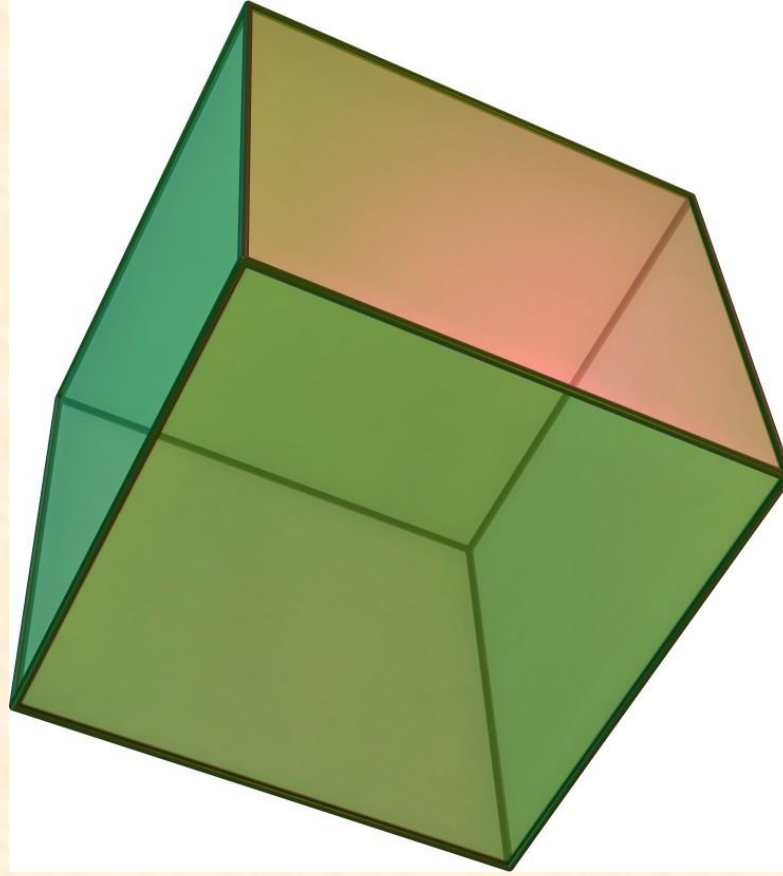

UPŞ`E

küp ... cub

www.danef.net





Trapezium
(Amer. Eng.)



Trapezoid (Amer. Eng.)
Trapezium (Brit. Eng.)

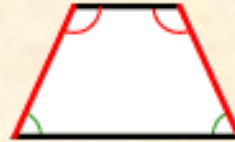

Isosceles trapezoid (Am.)
Isosceles trapezium (Br.)



Parallelogram

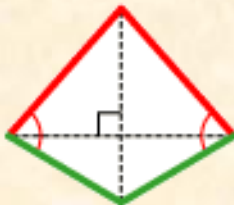

Kite



Rhombus



Rectangle

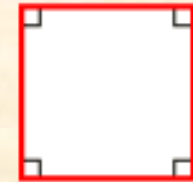

Square

PIĽ`ENABZ

dörtgen ... quadrilateral



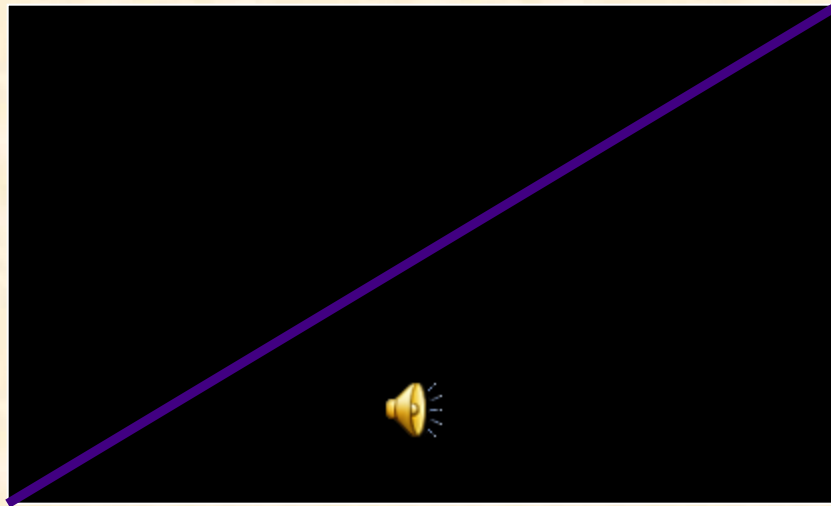

PIĻ`ANE

dikdörtgen ... rectangle

www.danef.net



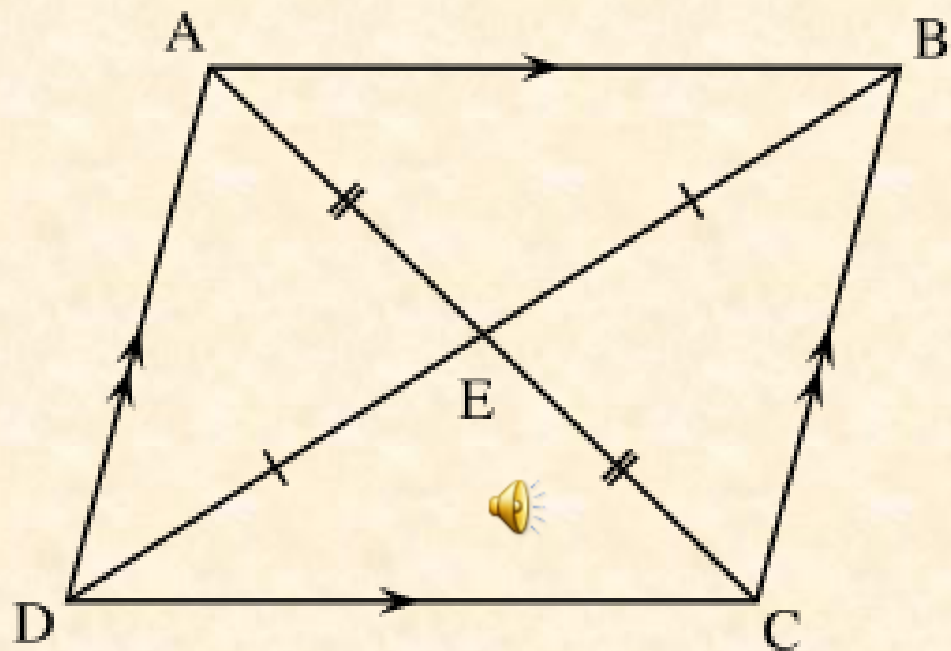

PIŢ'ANE PARELEL

paralelkenar ... paralelogram

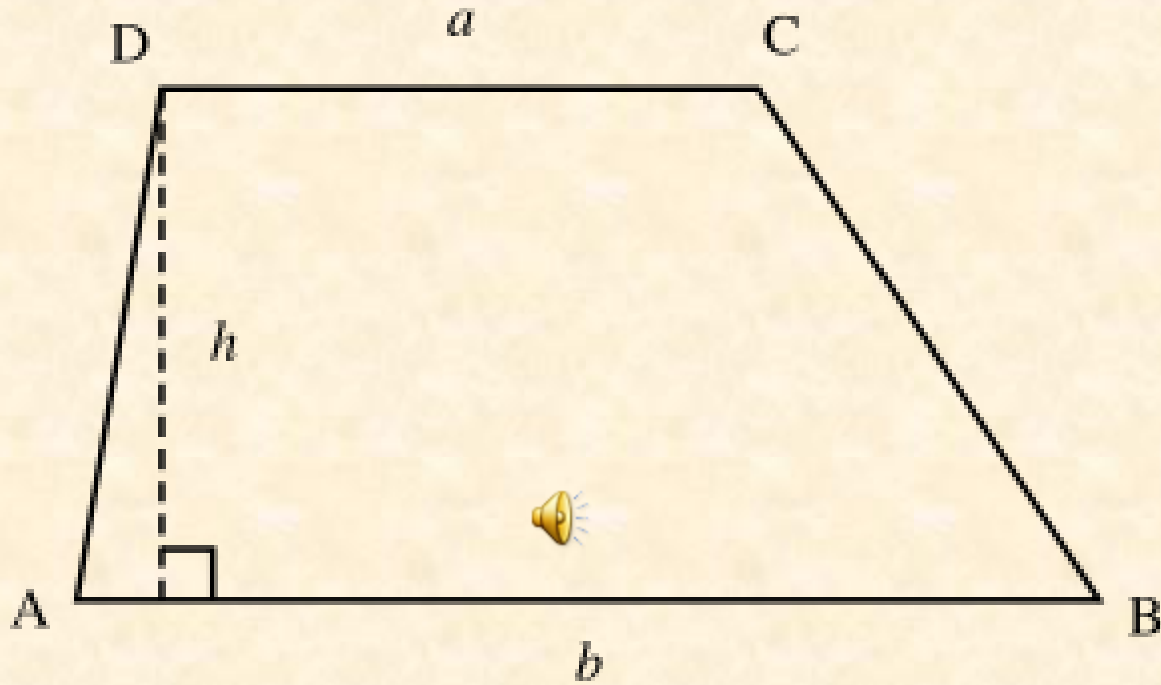

PIR'ANE UŐE

yamuk ... trapezoid

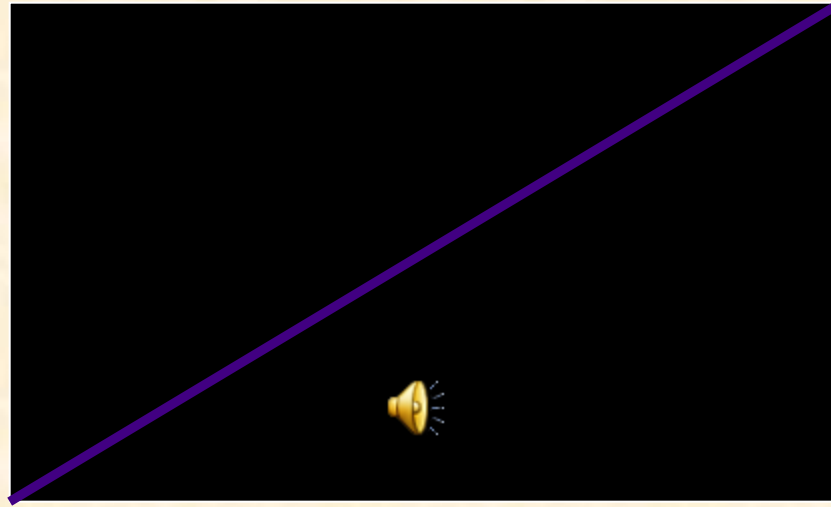

ZEBLEŽIĀ

köşegen ... diagonal



XIME

altigen

www.danef.net





ŞİME

üçgen ... triangle

www.danef.net



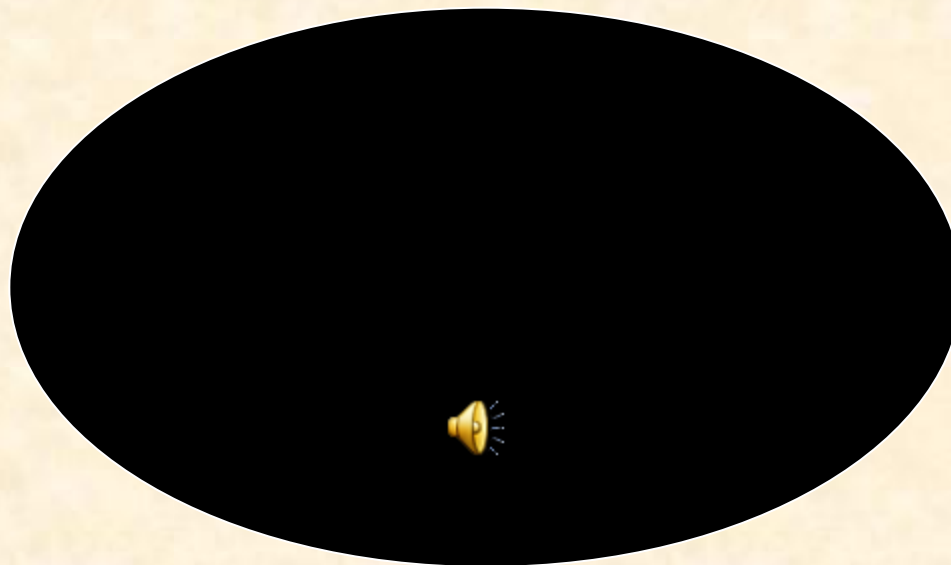

UĆEH

elips ... ellipse

www.danef.net





PIŁ`IME

kare ... square

www.danef.net





ĆAŔEM YİBAĖE

yüzölçümü ... area

www.danef.net



$$\begin{array}{r|l} 35 & 8 \\ \hline 32 & 4 \\ \hline 3 & \end{array}$$

KÉLIRER

kalan ... remainder

$$\begin{array}{r|l} 35 & 8 \\ 32 & 4 \\ \hline 3 & \end{array}$$



GOŞIRE

bölünen ... dividend

$$\begin{array}{r|l} 35 & 8 \\ 32 & 4 \\ \hline 3 & \end{array}$$



GOŞIĞ

bölüm ... divisor

$$\begin{array}{r|l} 35 & 8 \\ 32 & 4 \\ \hline 3 & \end{array}$$



ZİGOŞİRE

bölen ... divisor

$$\sqrt{64} = 8$$

KARELAPS

karekök ... square root





KILOWITF

5 KG





METREM KILOW TEGOŠAĖEW TIU

2 MT / KG

www.danef.net





KILOM SANTĪMKAREW TEGOŠAĖW
BĖU

9 KG / CM²

www.danef.net





METREW KÜBEW BLI

7 M3

www.danef.net





METREWİŐ

3 MT

www.danef.net





METREWKAREW XI

6 M2

www.danef.net





PÇAĞE

rakam ... digit

www.danef.net





ŞEMYETİĞEW

%

www.danef.net





ĠEBEĠONIĠE





XEĀĀĆ

—

www.danef.net





GOŞ

/

www.danef.net





ZEFEDİZ

=

www.danef.net





ZÉXAΛHA



www.danef.net





YATIONERİYE

2.





YİLES MİNİTİURE TFİREM

2005 yılı

www.danef.net





YIŞANE

1/3





YIŞANİTİU

2/3





ZECERİY

toplamlam ... total

www.danef.net





ŞÖMBİĞOÁĞ

genişlik ... width

www.danef.net





ĆEHİĖE

uzunluk ... length

www.danef.net





ĽEĜAĜ

yükseklik ... heigth

www.danef.net





BĞOÁĞE

genişlik ... width

www.danef.net





ĶUWUĢE

derinlik ...

www.danef.net



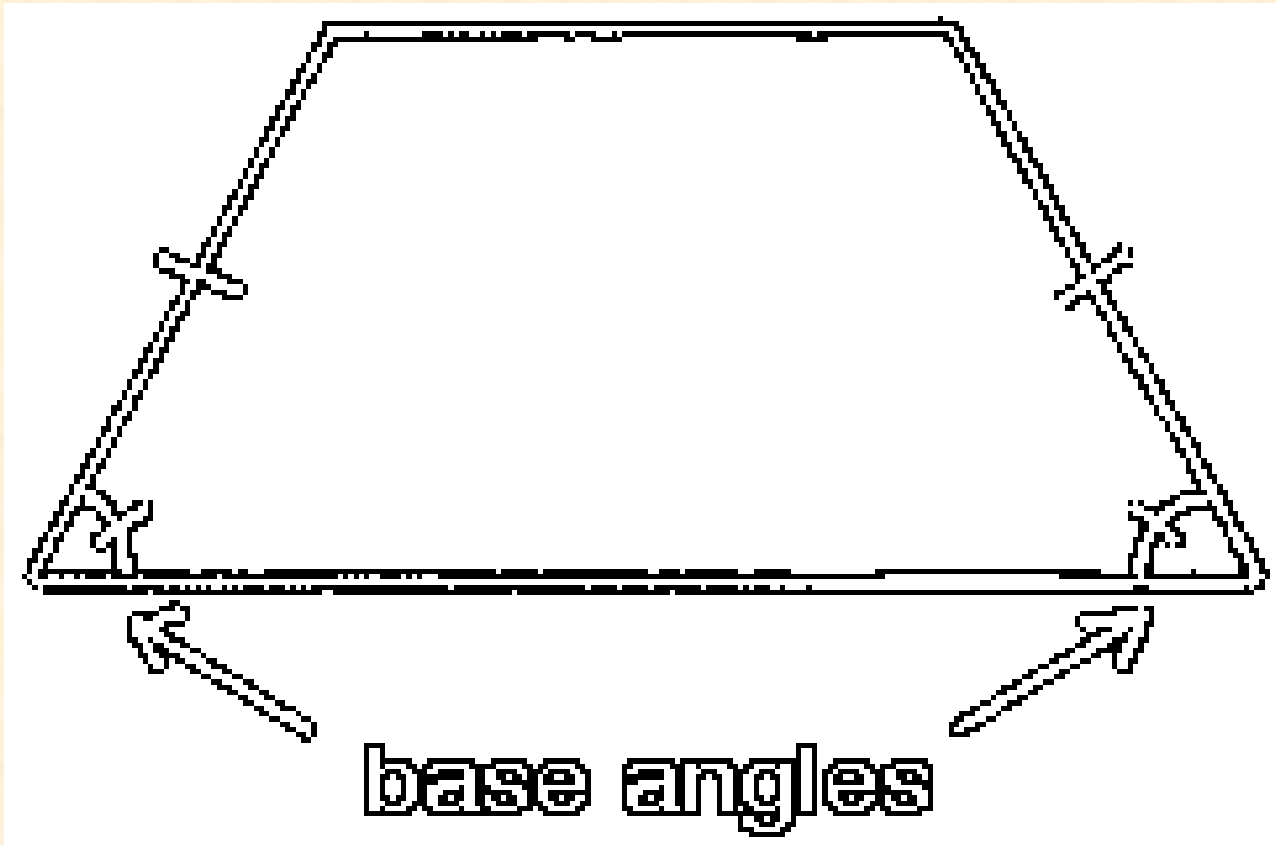

KOÁPE

açı ... angle

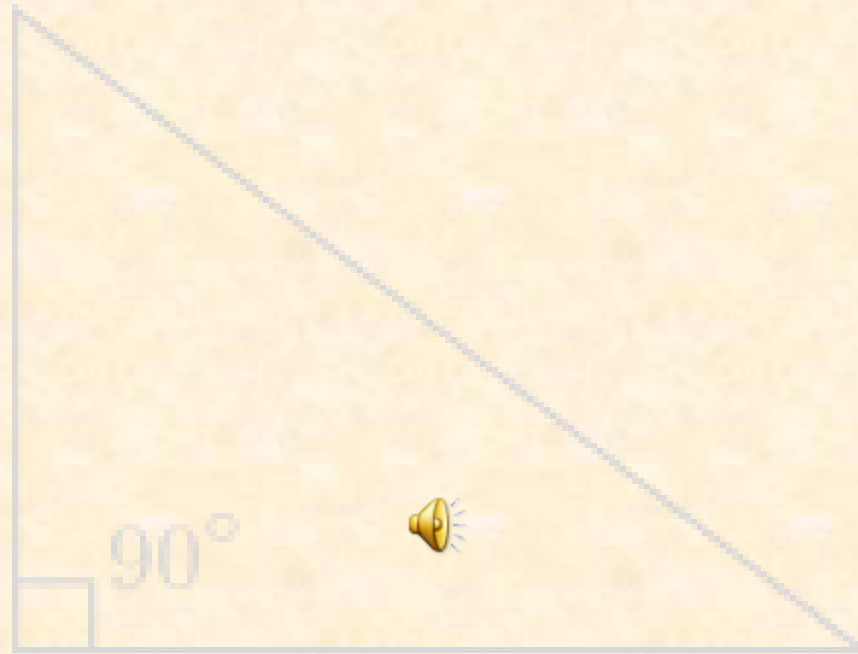

KOÁPE ZANĆ

dik aç1 ... right angle

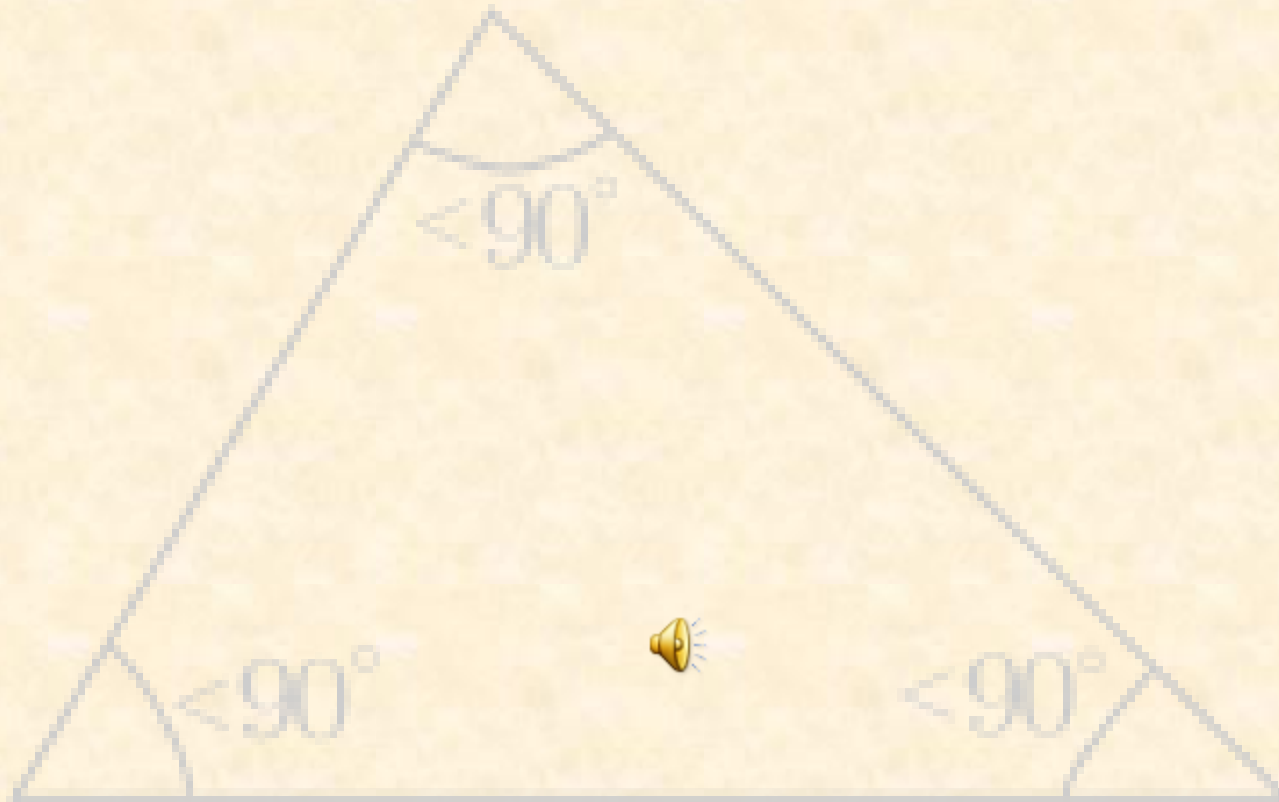

KOÁPE PAMŠ'

dar aç1 ... acute angle



ΚΟΑΨΕ ΡΑΚΥ

geniř aı ... obtuse angle